

FLOMAX

INTERNATIONAL



Product Catalog: Fluid Transfer Systems

QUALITY, INNOVATION & VALUE

Table Of Contents

<i>Product</i>	<i>Page</i>
<i>Fuel Nozzles 1 1/2"</i>	<i>1 & 2</i>
<i>Fuel Nozzles 2" FN800</i>	<i>3</i>
<i>Fuel Nozzles 2" FX1500.</i>	<i>4</i>
<i>Cross Section.</i>	<i>5</i>
<i>Tank Filling Time</i>	<i>6</i>
<i>External Line Non-Pressure Fueling System</i>	<i>7</i>
<i>Internal Line Non-Pressure Fueling System</i>	<i>8</i>
<i>Non-Pressure System Tank Configuration.</i>	<i>9</i>
<i>Non Pressure System Installation</i>	<i>10</i>
<i>Fuel Receivers.</i>	<i>11</i>
<i>3/4" Connectors.</i>	<i>12</i>
<i>High Flow 1" Connectors.</i>	<i>13</i>
<i>High Flow Nozzle - Receiver Flow Rates.</i>	<i>14</i>
<i>Coolant and Engine Connectors-Standard Series</i>	<i>15</i>
<i>Hydraulic and Transmission Connectors-Standard Series.</i>	<i>16</i>
<i>R-Series Coolant and Engine Connectors</i>	<i>17</i>
<i>R-Series Hydraulic and Transmission Connectors.</i>	<i>18</i>
<i>Flush Face Connectors</i>	<i>19</i>
<i>Grease Fittings.</i>	<i>20</i>
<i>Fuel Vents</i>	<i>21-22</i>
<i>Swivels and 1500 PSI Connector Series</i>	<i>23</i>
<i>Break Away Valves</i>	<i>24</i>
<i>3" Inch Fuel Nozzle and Receivers</i>	<i>25</i>
<i>Accessories</i>	<i>26</i>
<i>Tools</i>	<i>27</i>
<i>Special Products</i>	<i>28</i>
<i>Adapters</i>	<i>29</i>
<i>Bulk Transfer Nozzle & P-Caps</i>	<i>30</i>
<i>Notes</i>	<i>31</i>

1 Fuel Nozzles 1 1/2"

FloMAX Fuel nozzles have our patented modular back pressure sensor for reliable and repeatable shut off results every time. Our all metal construction ensures a long and durable life for the nozzle. Our FNBL nozzle can flow over 180 GPM (682 LPM) with an 1 1/2" hose and over 211 GPM with a 2" feed hose and a high pressure nozzle shut off. That is the highest flowing 1 1/2" fuel nozzle in the industry. It is easily cleaned and serviced in the field with our easy to remove pullback assembly.

- **Highest flow rate of any 1 1/2" diesel nozzle with a 1 1/2" hose.**
- **All metal construction with stainless steel nose.**
- **Lightest diesel nozzle in industry 5 lbs 14 oz.**
- **Factory adjustable shut off pressures.**
- **Will not flow when not connected to receiver.**

FNBL



The FNBL has a "Ball Lock" system that attaches nozzle to receiver.

FNBL

Part No.	Description
FNBL-P	Fuel Nozzle with Ball Lock with Swivel and Plug
FNBL	Fuel Nozzle with Ball Lock with Swivel No Plug
FNBL-P-NS	Fuel Nozzle with Ball Lock with Plug No Swivel
FNBL-NS	Fuel Nozzle with Ball Lock No Swivel No Plug
FNBL Repair	Fuel Nozzle Repair

FN600

Part No.	Description
FN600	Fuel Nozzle with Swivel and Plug
FN600-NS	Fuel Nozzle with Plug No Swivel
FN600 Plug	Fuel Nozzle Sealing Plug
FN600 Repair	Fuel Nozzle Repair

FNBL-NI-P

This non-interchangeable nozzle is used to help prevent theft or use with different bio diesel blends. Will not connect to standard fuel receivers.

Part No.	Description
*FNBL-NI-P	Fuel Nozzle Non-Interchangeable w/ Swivel and Plug
FNBL-NI	Fuel Nozzle Non-Interchangeable w/ Swivel No Plug
FNBL-NI-P-NS	Fuel Nozzle Non-Interchangeable w/ Plug No Swivel
FNBL-NI-NS	Fuel Nozzle Non-Interchangeable w/ No Swivel No Plug
*FNBL-NI-P	Fuel Nozzle Non-Interchangeable w/ Swivel and Plug

* **Must be used w/ the FRA-NI-C fuel receiver.**

FloMAX Fuel nozzles have our patented modular back pressure sensor for reliable and repeatable shut off results every time. Our all metal construction ensures a long and durable life for the nozzle. FN600 nozzle can flow up to 180 GPM (682 LPM) with an 1 1/2" hose and over 211 GPM with a 2" feed hose and a high pressure nozzle shut off. That is the highest flowing 1 1/2" fuel nozzle in the industry. It is easily cleaned and serviced in the field with our easy to remove pullback assembly.

- **Highest flow rate of any 1 1/2" diesel nozzle.**
- **All metal construction with stainless steel nose.**
- **Lightest diesel nozzle in industry 5 lbs 14 oz.**
- **Factory adjustable shut off pressures.**

FN600



The FN600 has a "Dog Lock" system to attach nozzle to receiver.

FNBL-NI-P



FRA-NI-C

3 Fuel Nozzles 2" FN800

FloMAX FN800 fuel nozzles have our patented modular back pressure sensor for reliable and repeatable shut off results at all flows, every time. It is the highest flowing 1 ½" fuel nozzle in the industry with a 211+ GPM (800 LPM+) rating with a 2" inlet hose. It is easily cleaned and serviced in the field with our easy to remove pullback assembly. Factory adjustable shut off pressure. Will not flow when not connected to a receiver.

- **Highest flowing 1½" nozzle in the industry, 211+ GPM.**
- **All metal construction with stainless steel nose.**
- **Simple upgrade from the standard FNBL or FN600 nozzle.**
- **Used with standard fuel receivers.**

FN800



Part No.	Description
FN800-P	Fuel nozzle with ball lock, 2" inlet swivel and plug
FN800	Fuel nozzle with ball lock, 2" inlet swivel, No Plug
FN800-P-NS	Fuel nozzle with ball lock, with Plug, No swivel
FN800	FN800-NS Fuel nozzle w/ ball lock, No swivel, No Plug

FloMAX FX1500 2" fuel nozzle uses the same all metal construction as our industry leading FNBL nozzle and also has the patented back pressure sensor. It is the highest flowing fuel nozzle in the industry with flows over 400 GPM (1500+LPM).

- Highest flowing 2" nozzle in the industry, 400 GPM.
- All metal construction with stainless steel nose.
- Simple upgrade from the 1 1/2" system.
- Connects to our 2" FRX Fuel Receiver.
- Receiver mounts in 2" NPT Bung.

FX1500



FRX-C 2"



Part No.	Description
FX1500	2" High Flow Fuel Nozzle with No Swivel No Plug
FX1500-S	2" High Flow Fuel Nozzle with Swivel No Plug
FX1500-P	2" High Flow Fuel Nozzle Plug No Swivel
FX1500-S-P	2" High Flow Fuel Nozzle with Swivel and Plug
FX1500 Plug	2" High Flow Fuel Nozzle Sealing Plug
FX1500 Repair	2" High Flow Fuel Nozzle Repair

Cross Section

Flomax Fuel Receiver

Venturi design increases and smoothes the flow of fuel.

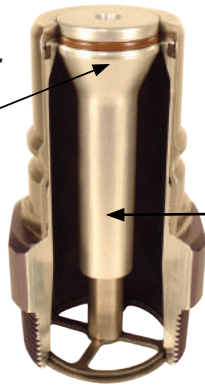

Patented internal spring creates a smooth flow path and less vibration.

Competition Fuel Receiver

Highly restrictive poppet increases back pressure and decreases flow.

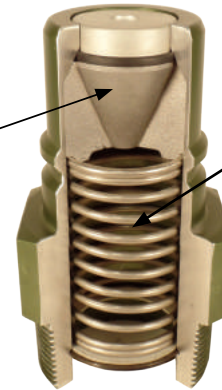

Spring in flow path creates turbulence, restriction and vibration. This causes pre-mature failure of the fuel nozzle poppet.

FX1500

Flows up to 400 GPM (1500 CPM)

Vulcanized viton double rib seal for ultimate sealing to the receiver.

Double fluorosilicone O-rings for long life in all temperatures.

Aircraft grade aluminum pullback.

Nickle plated wear sleeve for long lasting reliable performance.

2 fluorosilicone O-rings for exceptional cold and hot weather performance.

Stainless steel nose for added strength and durability.

Radiused dynamic smooth flow path.

2" inlet for increased flow.

Patented modular back pressure sensor ensures linear shut off at all flow rates.

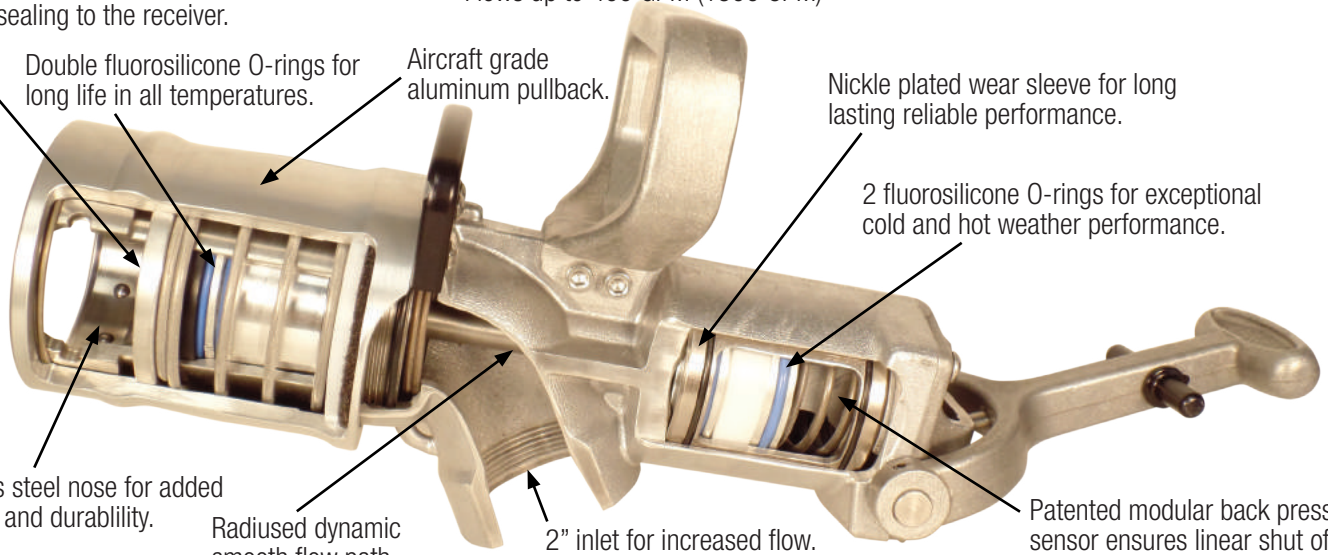

- Highest flowing 2" nozzle in the industry, 400 GPM.
- All metal construction with stainless steel nose.
- Simple upgrade from the 1 1/2" system.
- Connects to our 2" FRX Fuel Receiver.
- Receiver mounts in 2" NPT Bung.

FNBL

Flows up to 211 GPM, with the same features listed on the FX1500 above.

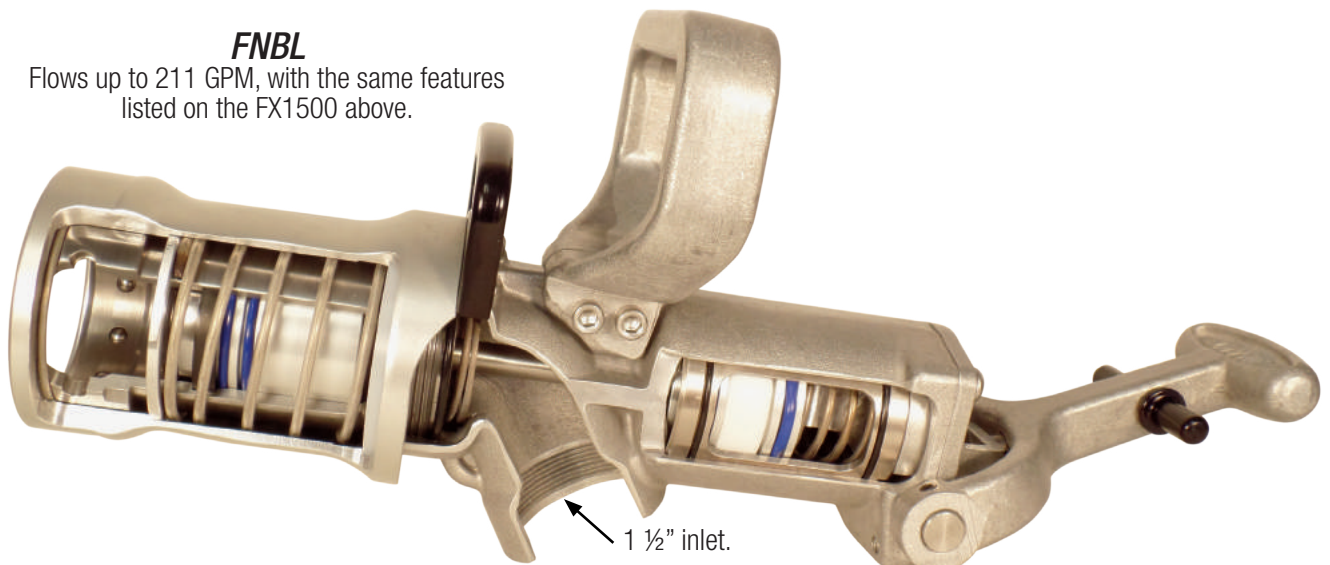

1 1/2" inlet.

- Highest flowing 1 1/2" nozzle in the industry, 211 GPM.
- All metal construction with stainless steel nose.
- Simple upgrade from the 1 1/2" system.
- Connects to our 1 1/2" Fuel Receiver.
- Receiver mounts in 2" NPT Bung.

Time to Fill a Fuel Tank in Seconds per Inch				
180 GPM:	1.9 sec/in	3.3 sec/in	5.2 sec/in	7.5 sec/in
150 GPM:	2.2 sec/in	4.0 sec/in	6.2 sec/in	9.0 sec/in
120 GPM:	2.8 sec/in	5.0 sec/in	7.8 sec/in	11.2 sec/in
TANK SIZE IN FEET	3'X3'			
TANK SIZE CU. IN	1,296 in ²			
• Fuel rises faster in a tall, narrow tank than shorter and wider tanks.		4'X4' 2,300 in ²		
• Enough ullage needs to be left at the top of the tank to accommodate for fill rate and tank size and shape.			5'X5' 3,600 in ²	
• Improper and inadequate venting is a common cause of filling problems when using high fill rate nozzles.				6'X6' 5,184 in ²
• Make sure there is a free and unrestricted air path out of the tank.				

Factors that affect fuel nozzle shut off

- Tall narrow tank which can increase head pressure on the receiver
- Long or circuitous flow path of feed hose after receiver.
- Inadequate venting of tank causing pressurization while filling.
- Restriction in flow path after the receiver.
- Low pressure nozzle not correct for tank configuration

Factors that can cause fuel to spill out of vent

- Too short of a internal stem vent. Does not allow proper pressurization prior to overfilling tank.
- Non pressure system sensing line is damaged or not hooked up.
- Too slow of a fill rate to properly operate the nozzle. Needs to be 40 GPM minimum.
- High pressure nozzle not correct for tank configuration and ullage.

Factors that can affect non pressure fueling systems

- Most systems need a higher pressure shut off nozzle to function correctly.
- Filling at too low of a fill rate. Needs to be 40 GPM minimum.
- Sensing line between vent and receiver is blocked or disconnected or damaged.
- Inadequate venting of tank.
- Restricted vent holes during installation.

7 External Line Non-Pressure Fueling System

External system is rated at 400 GPM with our standard fuel nozzles. Our external line system fits into all standard 2" NPT openings.

- Patent pending design reduces fuel foaming and increases flow due to an unrestricted "straight through" flow path.
- Factory tested prior to shipping.
- Integrated roll over spill protection.
- Optional rotatable vent top.
- The FloMAX external line system can flow over 400 GPM, higher flow rates than all other competitors.
- All stainless steel and aircraft grade aluminum construction means they are built to last.
- Compatible with all tank types (plastic & steel).

NPS-1



NPS Filter Kit

Part No.	Description
NPS-1	External Kit with Rec., hose and fitting
NPS-1-NH	External Kit with Rec. no hose, fitting
NPS-1-F	External Kit with vent top, hose, fittings
NPS-1-F-NH	External Kit with vent top, no hose, fittings

Part No.	Description
NPS-Filter Kit	NPS Filter Kit, bracket and filter
NPS-FB	NPS Filter Bracket Black anodized
NPS-Filter	NPS Filter
VT-NP-E	Non-Pressure 2" Vent external hose applications
NPV	Non Pressure Valve External

Internal Line Non-Pressure Fueling System

8

All stainless steel and aircraft grade aluminum construction means they are built to last. Our internal line system fits into all standard 2" NPT openings and the receiver is the same size as a STANDARD FUEL RECEIVER! All of your current safety enclosures and panel boxes will still work as designed with our internal non-pressure system. This demonstrates FloMAX innovation.

- Patent pending design reduces fuel foaming and increases flow due to an unrestricted "straight through" flow path.
- Compatible with all tank types (plastic and steel).
- Integrated roll over spill protection.
- Factory tested prior to shipping.
- Optional rotating vent top.
- Internal system is rated at 200 GPM with our standard fuel nozzles.
- Optional rotating vent top.



Part No.	Description
NPS-2	Internal Kit with hose and fittings
NPS-2-NH	Internal Kit no hose, fittings
NPS-2-F	Internal Kit with vent top, hose, fittings
NPS-2-F-NH	Internal kit with vent top, no hose, fittings

Part No.	Description
NPS-Filter Kit	NPS Filter Kit, bracket and filter
NPS-FB	NPS Filter Bracket Black anodized
NPS-Filter	NPS Filter
VT-NP-I	Non-Pressure 2" Vent Internal hose applications
FR-NP-C	Non Pressure Valve Internal

9 Non Pressure System Tank Configuration

External System: 400 GPM Capable
Drop Down tube is preferred installation on both vent types.

Remove rubber cover and screen before installing drop hose.

Internal System: Fits in standard enclosures, 200 GPM Capable, Excellent slosh resistance

External Tank Empty

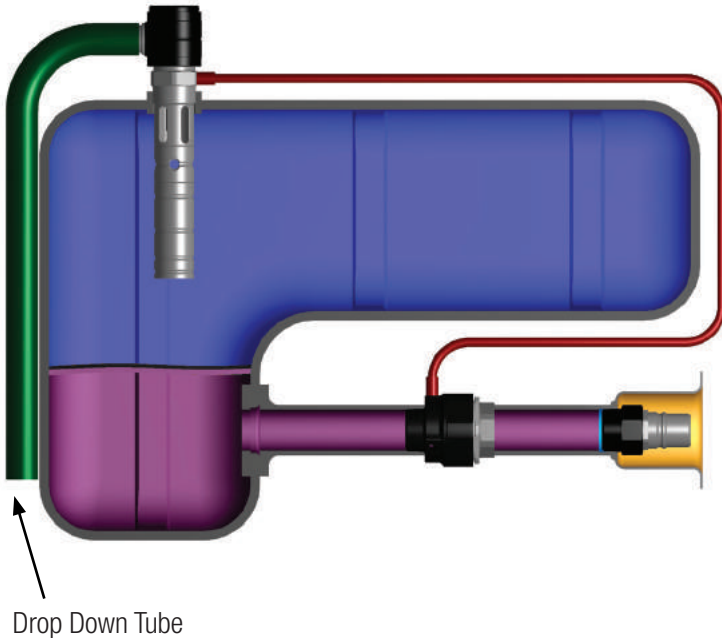

External Tank Full

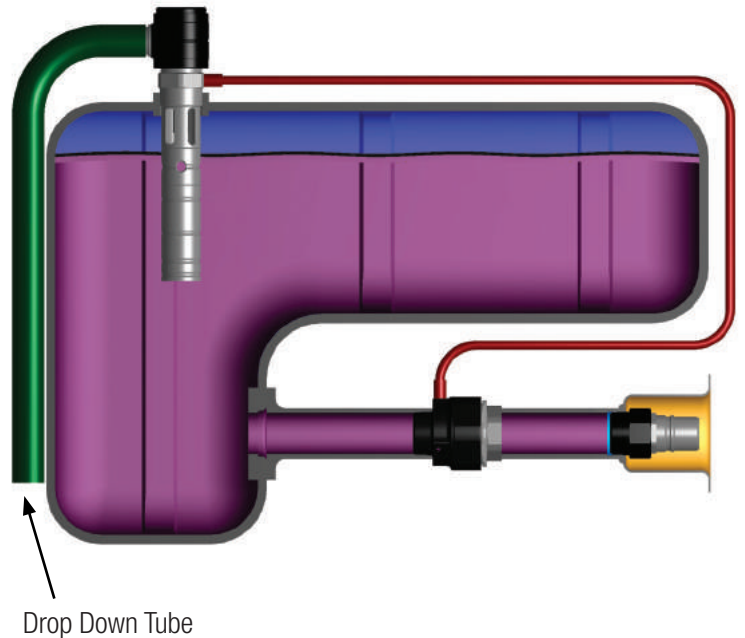

Internal Tank Empty

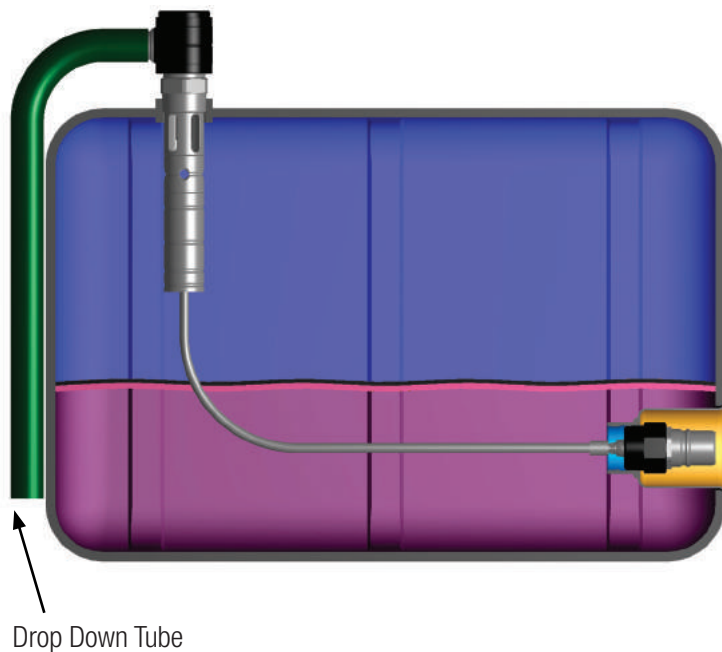

Internal Tank Full

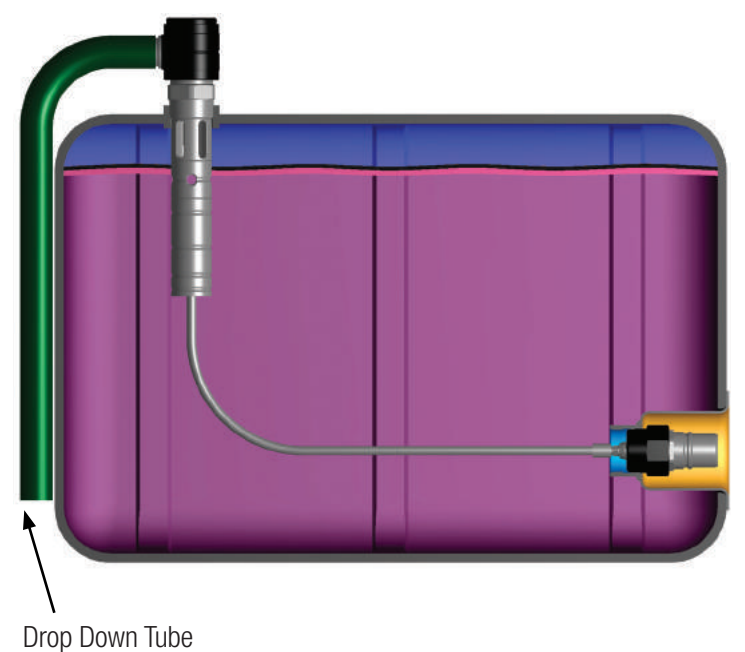

Note: All tanks shown with green drop down tubes.

Always use a high pressure shut off fuel nozzle for all non pressure system installations.

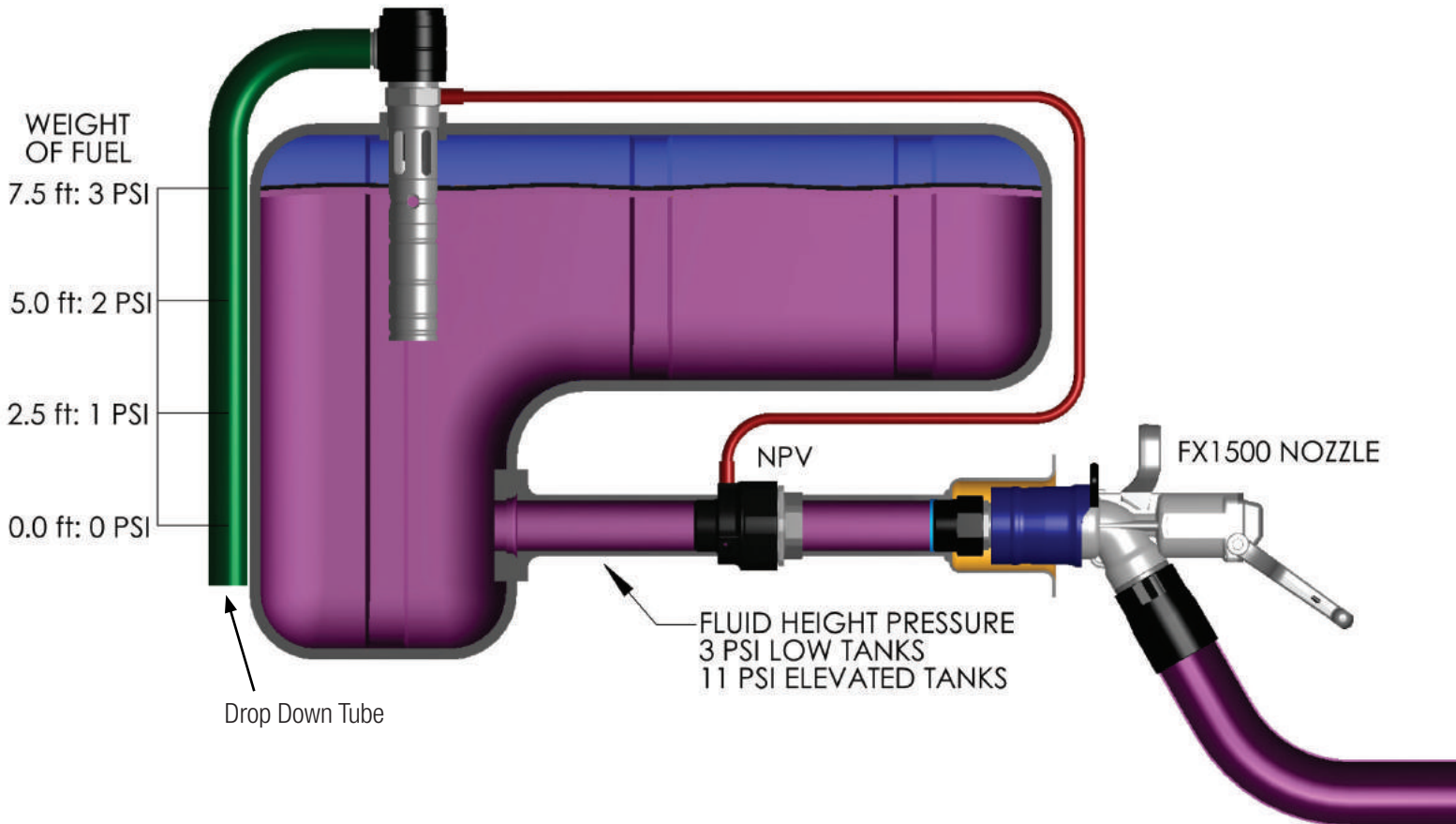

Installation tips:

- *Keep the sensing line hose free of excessive bends; less than three 90° bends preferred. The external hose may need to be cut to length.*
- *The internal NPS hose connections are located on the bottom of the VT-NP and the rear of the FR-NP.*
- *The external NPS hose connections are located above the threads where the VT-NP mounts to the tank and one of the three ports on the exterior of the NPV.*
- *For the external system, the NPV mounts between the tank and a low pressure fuel receiver. The NPV has a specified flow direction that is indicated on the part.*
- *For the internal system, the FR-NP retains the same dimensions as a standard fuel receiver and mounts directly to the tank.*

11 Fuel Receivers

All FloMAX Fuel receivers have our patented enclosed poppet stem spring for a smooth and higher flowing fuel path. This greatly enhances the life of both the receiver and fuel nozzle due to the decrease in fuel restriction and vibration.

Our FR-RS series of fuel receivers have a patented removable stainless steel wear sleeve. This revolutionary patented concept allows the fuel receiver wear surface to be replaced very quickly and easily without removing the fuel receiver from the tank or the loss of any fuel. It uses the same internal spring concept that has been so successful in our other receivers.

- Patented internal spring reduces vibration and increases flow.
- Patented removable wear sleeve allows easy replacement without draining tank (FR-RS Only).
- Available in both standard and low pressure models.

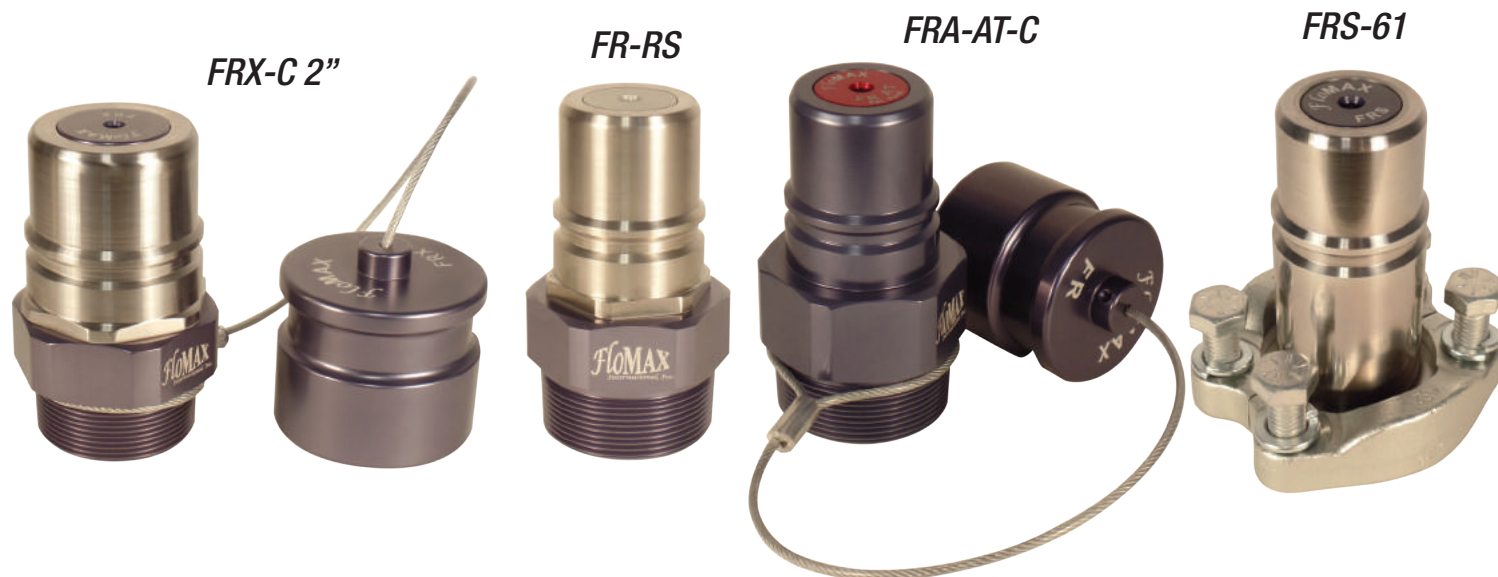

Part No.	Description
FRS	Fuel Receiver - Steel
FRS-C	Fuel Receiver - Steel with Cap
FRA	Fuel Receiver - Aluminum
FRA-C	Fuel Receiver - Aluminum With Cap
FRA-AT	Fuel Receiver Aluminum - Anti Theft
FRA-AT-C	Fuel Receiver Aluminum - Anti Theft with Cap
FR-RS	Fuel Receiver w/Removable Sleeve
FR-RS-AT	Fuel Receiver w/Removable Sleeve - Anti Theft
FR-RS-AT-C	Fuel Receiver w/REM Sleeve - Anti Theft with Cap

Part No.	Description
FR-RS-R	Fuel Receiver w/REM Sleeve - Replacement Sleeve
FRA-NI*	Fuel Receiver Non-Interchangeable
FRA-NI-C*	Fuel Receiver Non-Interchangeable, with Cap
FRX	Fuel Receiver 2"
FRX-C	Fuel Receiver 2" with Cap
FRX Cap	Fuel Receiver 2" Cap
FR Cap	Fuel Receiver Cap
FR P Cap	Fuel Receiver Cap - Push -On Mechanically Locking
FRS-61	Stainless Fuel Receiver Code 61 Flange
FRS-61-C	Stainless Fuel Receiver Code 61 Flange w/Cap

* , USE WITH FNBL-NI ONLY See Page 2

FR-P Cap



FR-P Cap and FRX-P Cap Available.
Spring Clip Option Available For All
Fuel Receivers.

FR P Cap and FRX P Cap are a Flomax innovation for an easily installed and removed fuel receiver cap. The push to connect design allows easy installation in all weather conditions. The FR P cap fits all standard fuel receivers. The FRX P Cap fits our high flowing 2" FRX Fuel receivers.

FloMAX has a unique series of connectors designed for great fluid flow and to help prevent cross contamination. Each colored connector is non-interchangeable with the other color connectors. All wear components are made from Stainless steel and non-wear components are aircraft grade anodized aluminum. The stainless steel latching mechanism ensures a long lasting and robust connection every time.

- FloMAX invented the non-interchangeable series of connectors.
- Eliminates cross contamination.
- All metal construction ensures longevity.
- 50 GPM.
- NPTM 3/4" Thread Size.
- 500 PSI Working Press.

ENBL



ERS

JIC Ends Available



ERJ



Colors Available:

- Red ●
- Gold ●
- Teal ●
- Violet ●
- Navy ●
- Brown ●

Part No.	Description
ENBL #1	Engine Nozzle Ball Lock #1 - Red
ENBL-P #1	Engine Nozzle Ball Lock w/ Plug #1 - Red
ENBL #1 Plug	Engine Nozzle Ball Lock Plug #1 - Red
ERS #1	Engine Receiver #1 - Red
ERS-C #1	Engine Receiver w/ Cap #1 - Red
ERS #1 Cap	Engine Receiver Cap #1 - Red
ERJ #1	Engine Receiver with JIC Bulkhead Base #1 - Red
ERJ-C #1	Engine Receiver w/JIC Bulkhead Base w/ Cap #1 - Red
ENBL #2	Engine Nozzle Ball Lock #2 - Gold
ENBL-P #2	Engine Nozzle Ball Lock w/ Plug #2 - Gold
ENBL #2 Plug	Engine Nozzle Ball Lock Plug #2 - Gold
ERS #2	Engine Receiver #2 - Gold
ERS-C #2	Engine Receiver w/ Cap #2 - Gold
ERS #2 Cap	Engine Receiver Cap #2 - Gold
ERJ #2	Engine Receiver with JIC Bulkhead Base #2 - Gold
ERJ-C #2	Engine Receiver w/ JIC Bulkhead Base w/ Cap #2 - Gold
ENBL #3	Engine Nozzle Ball Lock #3 - Teal
ENBL-P #3	Engine Nozzle Ball Lock w/ Plug #3 - Teal
ENBL #3 Plug	Engine Nozzle Ball Lock Plug #3 - Teal
ERS #3	Engine Receiver #3 - Teal
ERS-C #3	Engine Receiver w/ Cap #3 - Teal
ERS #3 Cap	Engine Receiver Cap #3 - Teal
ERJ #3	Engine Receiver with JIC Bulkhead Base #3 - Teal
ERJ-C #3	Engine Receiver w/ JIC Bulkhead Base w/ Cap #3 - Teal

Part No.	Description
ENBL #4	Engine Nozzle Ball Lock #4 - Violet
ENBL-P #4	Engine Nozzle Ball Lock w/ Plug #4 - Violet
ENBL #4 Plug	Engine Nozzle Ball Lock Plug #4 - Violet
ERS #4	Engine Receiver #4 - Violet
ERS-C #4	Engine Receiver w/ Cap #4 - Violet
ERS #4 Cap	Engine Receiver Cap #4 - Violet
ERJ #4	Engine Receiver with JIC Bulkhead Base #4 - Violet
ERJ-C #4	Engine Receiver w/ JIC Bulkhead Base w/ Cap #4 - Violet
ENBL #5	Engine Nozzle Ball Lock #5 - Navy
ENBL-P #5	Engine Nozzle Ball Lock w/ Plug #5 - Navy
ENBL #5 Plug	Engine Nozzle Ball Lock Plug #5 - Navy
ERS #5	Engine Receiver #5 - Navy
ERS-C #5	Engine Receiver w/ Cap #5 - Navy
ERS #5 Cap	Engine Receiver Cap #5 - Navy
ERJ #5	Engine Receiver with JIC Bulkhead Base #5 - Navy
ERJ-C #5	Engine Receiver w/ JIC Bulkhead Base w/ Cap #5 - Navy
ENBL #6	Engine Nozzle Ball Lock #6 - Copper
ENBL-P #6	Engine Nozzle Ball Lock w/ Plug #6 - Copper
ENBL #6 Plug	Engine Nozzle Ball Lock Plug #6 - Copper
ERS #6	Engine Receiver #6 - Copper
ERS-C #6	Engine Receiver w/ Cap #6 - Copper
ERS #6 Cap	Engine Receiver Cap #6 - Copper
ERJ #6	Engine Receiver with JIC Bulkhead Base #6 - Copper
ERJ-C #6	Engine Receiver w/ JIC Bulkhead Base w/ Cap #6 - Copper

13 High Flow 1" Connectors

The High Flow series of connectors have the same non interchangeable feature as the 3/4" series but are in a higher flowing 1" NPT size.

- **Flow rate of 113 GPM.**
- **Seven Non interchangeable colors.**
- **1" NPT base.**
- **500 PSI Operating Pressure.**

HFN



Part No.	Description
HFN #1	High Flow Nozzle #1 - Red
HFN-P #1	High Flow Nozzle w/ Plug #1 - Red
HFN #1 Plug	High Flow Nozzle Plug #1 - Red
HFR #1	High Flow Receiver #1 - Red
HFR-C #1	High Flow Receiver w/ Cap #1 - Red
HFR #1 Cap	High Flow Receiver Cap #1 - Red
HFN #2	High Flow Nozzle #2 - Gold
HFN-P #2	High Flow Nozzle w/ Plug #2 - Gold
HFN #2 Plug	High Flow Nozzle Plug #2 - Gold
HFR #2	High Flow Receiver #2 - Gold
HFR-C #2	High Flow Receiver w/ Cap #2 - Gold
HFR #2 Cap	High Flow Receiver Cap #2 - Gold
HFN #3	High Flow Nozzle #3 - Teal
HFN-P #3	High Flow Nozzle w/ Plug #3 - Teal
HFN #3 Plug	High Flow Nozzle Plug #3 - Teal
HFR #3	High Flow Receiver #3 - Teal
HFR-C #3	High Flow Receiver w/ Cap #3 - Teal
HFR #3 Cap	High Flow Receiver Cap #3 - Teal
HFN #4	High Flow Nozzle #4 - Violet
HFN-P #4	High Flow Nozzle w/ Plug #4 - Violet
HFN #4 Plug	High Flow Nozzle Plug #4 - Violet

HFR



Colors Available:	
Red	
Gold	
Teal	
Violet	
Navy	
Brown	
Blue/Grey	

Part No.	Description
HFR #4	High Flow Receiver #4 - Violet
HFR-C #4	High Flow Receiver w/ Cap #4 - Violet
HFR #4 Cap	High Flow Receiver Cap #4 - Violet
HFN #5	High Flow Nozzle #5 - Navy
HFN-P #5	High Flow Nozzle w/ Plug #5 - Navy
HFN #5 Plug	High Flow Nozzle Plug #5 - Navy
HFR #5	High Flow Receiver #5 - Navy
HFR-C #5	High Flow Receiver w/ Cap #5 - Navy
HFR #5 Cap	High Flow Receiver Cap #5 - Navy
HFN #6	High Flow Nozzle #6 - Copper
HFN-P #6	High Flow Nozzle w/ Plug #6 - Copper
HFN #6 Plug	High Flow Nozzle Plug #6 - Copper
HFR #6	High Flow Receiver #6 - Copper
HFR-C #6	High Flow Receiver w/ Cap #6 - Copper
HFR #6 Cap	High Flow Receiver Cap #6 - Copper
HFN #7	High Flow Nozzle #7 - Blue/Grey
HFN-P #7	High Flow Nozzle w/ Plug #7 - Blue/Grey
HFN #7 Plug	High Flow Nozzle Plug #7 - Blue/Grey
HFR #7	High Flow Receiver #7 - Blue/Grey
HFR-C #7	High Flow Receiver w/ Cap #7 - Blue/Grey
HFR #7 Cap	High Flow Receiver Cap #7 - Blue/Grey

The High Flow Nozzle (HFN) and High Flow Receiver (HFR) line of dry break fittings consist of seven sets of fittings with each pair offering a minimum flow area equivalent to 1" schedule 80 pipe. The fittings incorporate the following design features:

- 1) The receiver and nozzle of each set will only couple with each other offering complete protection against cross contamination of fluids.
- 2) Receiver and nozzle sets are color coded to simplify identification of matching component sets.
- 3) All wear parts are constructed of 416 stainless steel for long life and corrosion resistance.
- 4) All non-wear components are constructed of anodized 6061 alloy aluminum for high strength, light weight, and corrosion resistance.
- 5) All fittings have a 500 psi working pressure rating with 1500 psi minimum burst pressure rating.
- 6) The standard mounting is 1" male NPT for all receivers and 1" female NPT for all nozzles with optional mounting configurations available.
- 7) All fittings incorporate a "ball lock" mechanism with 7/32" 440-C grade stainless steel balls to insure smooth and reliable operation.
- 8) Maximum flow rate using ISO 46 hydraulic oil (third party tested) is 113 gpm (428 lpm).

Physical Description:

	Length	Diameter	Hex Size	Weight
<i>Nozzle</i>	3.92" 100mm	2.50" 64mm	2" 51mm	1.3 lbs. 640g
<i>Receiver</i>	3.40" 86mm	1.85" 47mm	2" 51mm	0.6 lbs. 320g
<i>Coupled Set</i>	5.35" 136mm			

15 Coolant and Engine Connectors-Standard Series

FloMAX standard series connectors are fully compatible and interchangeable with industry standard connectors. They are 100% metal construction using stainless steel and anodized aircraft grade aluminum. The color coded and labeled mating components provide for quick and positive identification.

- All metal construction ensures reliable performance.
- Fits all industry standard connectors.
- Color coded for quick and easy identification.

Coolant Nozzle

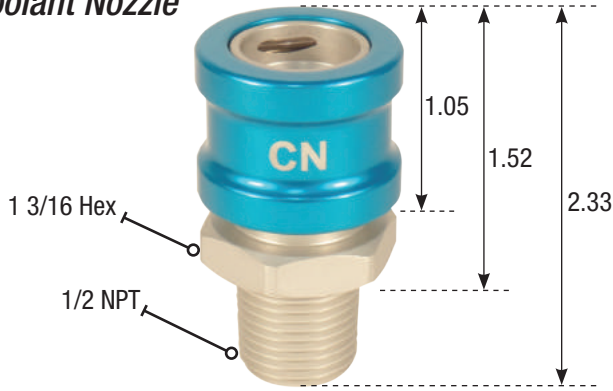

Part No.	Description
CN	Coolant Nozzle
CN-P	Coolant Nozzle w/ Plug
CN Plug	Coolant Nozzle Plug

Coolant Receiver

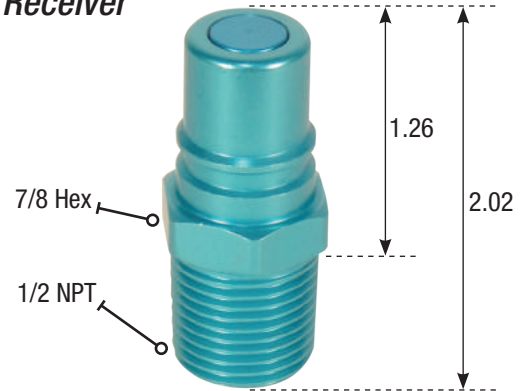

Part No.	Description
CR	Coolant Receiver
CR-C	Coolant Receiver w/ Cap
CR Cap	Coolant Receiver Cap

Engine Nozzle

- 50 GPM
- 500 PSI Working Pressure



Part No.	Description
ENBL	Engine Nozzle Ball Lock
ENBL-P	Engine Nozzle Ball Lock w/ Plug
ENBL Plug	Engine Nozzle Ball Lock Plug

Engine Receiver

- 50 GPM
- 500 PSI Working Pressure

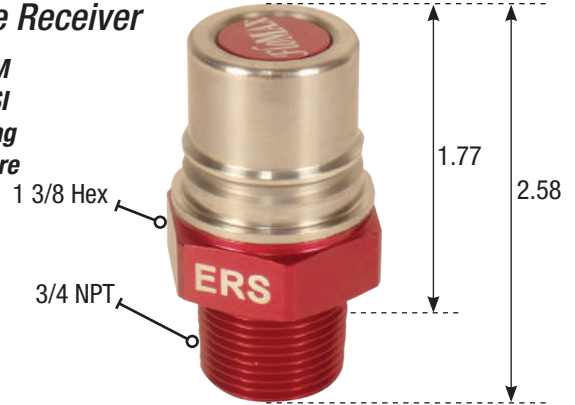

Part No.	Description
ERS	Engine Receiver
ERS-C	Engine Receiver w/ Cap
ERS Cap	Engine Receiver Cap
ERJ	Engine Receiver with JIC Bulkhead Base
ERJ-C	Engine Receiver with JIC Bulkhead Base w/ Cap
UN34	Universal 3/4" Series Draining Nozzle
UN34-P	Universal 3/4" Series Draining Nozzle w/Plug

UN34-P

UN34



UN34 and 34P Universal extraction nozzles fits all ERS 3/4 series receivers for easy evacuation and draining of tanks.

FloMAX standard series connectors are fully compatible and interchangeable with industry standard connectors. They are 100% metal construction using stainless steel and anodized aircraft grade aluminum. The color coded and labeled mating components provide for quick and positive identification.

- All metal construction ensures reliable performance.
- Fits all industry standard connectors.
- Color coded for quick and easy identification.

Hydraulic Nozzle

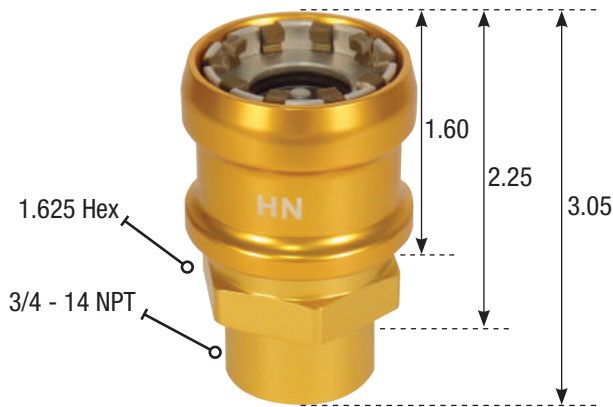

Part No.	Description
HN	Hydraulic Nozzle
HN-P	Hydraulic Nozzle w/ Plug
HN Plug	Hydraulic Nozzle Plug

Hydraulic Receiver



Part No.	Description
HR	Hydraulic Receiver
HR-C	Hydraulic Receiver w/ Cap
HR Cap	Hydraulic Receiver Cap

Transmission Nozzle



Part No.	Description
TN	Transmission Nozzle
TN-P	Transmission Nozzle w/ Plug
TN Plug	Transmission Nozzle Plug

Transmission Receiver



Part No.	Description
TR	Transmission Receiver
TR-C	Trans. Receiver w/ Cap
TR Cap	Trans. Receiver Cap

17 R-Series Coolant and Engine Connectors

FloMAX R-Series connectors are fully compatible and interchangeable with industry standard R-series connectors. They are 100% metal construction using stainless steel and anodized aircraft grade aluminum. The color coded and labeled mating components provide for quick and positive identification.

- All metal construction ensures long and reliable performance.
- Fits all industry R-series connectors.
- Color coded for quick and easy identification.

Coolant Nozzle



Part No.	Description
R-CN	R-Series Coolant Nozzle
R-CN-P	R-Series Coolant Nozzle w/ Plug
R-CN Plug	R-Series Coolant Nozzle Plug

Coolant Receiver



Part No.	Description
R-CR	R-Series Coolant Receiver
R-CR-C	R-Series Coolant Receiver w/ Cap
R-CR Cap	R-Series Coolant Receiver Cap

Engine Nozzle

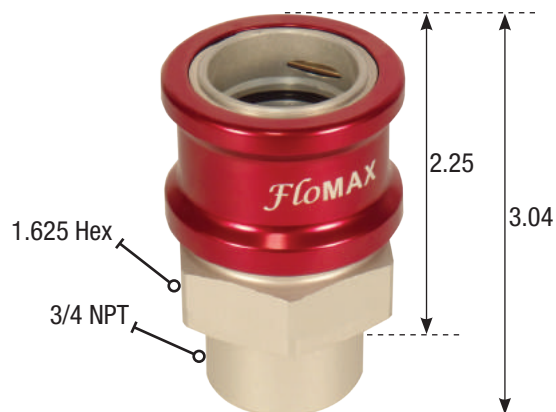

Part No.	Description
R-EN	R-Series Engine Nozzle
R-EN-P	R-Series Engine Nozzle w/ Plug
R-EN Plug	R-Series Engine Nozzle Plug

Engine Receiver



Part No.	Description
R-ER	R-Series Engine Receiver
R-ER-C	R-Series Engine Receiver w/ Cap
R-ER Cap	R-Series Engine Receiver Cap

FloMax R-Series Coolant and Engine connectors are fully compatible and interchangeable w/ industry standard R-Series connectors. The caps, plugs, and connectors are manufactured using aircraft grade anodized aluminum and color coded for quick and easy identification.

- **All metal construction ensures long and reliable performance.**
- **Fits all industry R-series connectors.**
- **Color coded for quick and easy identification.**

Hydraulic Nozzle



Part No.	Description
R-HN	R-Series Hydraulic Nozzle
R-HN-P	R-Series Hydraulic Nozzle w/ Plug
R-HN Plug	R-Series Hydraulic Nozzle Plug

Hydraulic Receiver

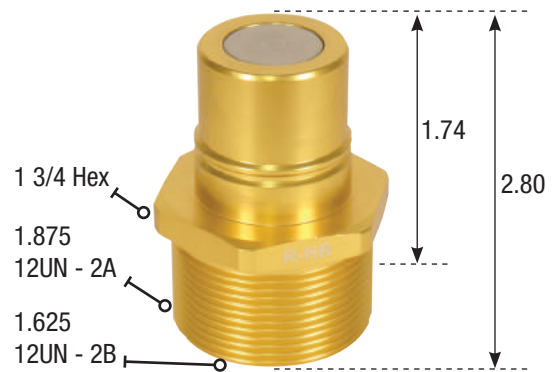

Part No.	Description
R-HR	R-Series Hydraulic Receiver
R-HR-C	R-Series Hydraulic Receiver w/ Cap
R-HR Cap	R-Series Hydraulic Receiver Cap

Transmission Nozzle



Part No.	Description
R-TN	R-Series Transmission Nozzle
R-TN-P	R-Series Trans. Nozzle w/ Plug
R-TN Plug	R-Series Transmission Nozzle Plug

Transmission Receiver



Part No.	Description
R-TR	R-Series Transmission Receiver
R-TR-C	R-Series Trans. Receiver w/ Cap
R-TR Cap	R-Series Trans. Receiver Cap

19 Flush Face Connectors

Our Patented non-interchangeable feature means each color will only mate with its corresponding colored receiver or nozzle.

- **New patented design uses an internally sealed ball lock mechanism to ensure trouble free performance even in the most harsh of conditions.**
- **12 color choices and sizes are available along with a universal evacuation nozzle.**
- **Additional special order sizes and colors are also available.**
- **Hardened stainless steel receiver nose ensures that FloMAX Flush Face connectors can be operated at a higher pressure than many other dry break connectors.**
- **All of the Flush Face connectors have the exact same outside dimensions.**
- **Can be connected or disconnected under pressure.**
- **Can be connected without pulling back on the nozzle pullback.**
- **Flush Face Nozzle and Receiver available in JIC base configuration.**
- **500 PSI Working Pressure.**
- **50 GPM Flow Rate.**

Flush Face Nozzle *Also Available in 3/4 Female NPT



Flush Face Receiver

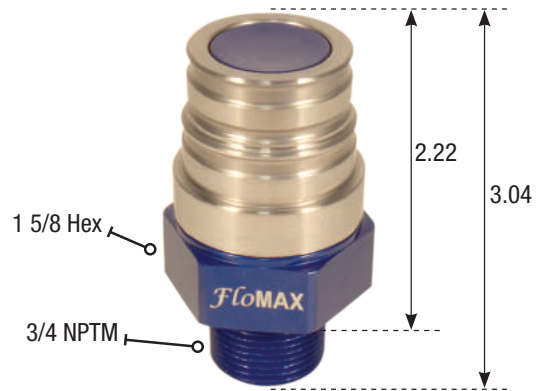

- Colors Available:
- Red
 - Gold
 - Teal
 - Violet
 - Navy
 - Brown
 - Blue/Grey
 - Clear
 - Green
 - Grey
 - Bronze
 - Orange

Part No.	Description
FLN #1	Flush Face Nozzle - Red
FLN #2	Flush Face Nozzle - Gold
FLN #3	Flush Face Nozzle - Teal
FLN #4	Flush Face Nozzle - Purple
FLN #5	Flush Face Nozzle - Dark Blue
FLN #6	Flush Face Nozzle - Brown
FLN #7	Flush Face Nozzle - Blue/Gray
FLN #8	Flush Face Nozzle - Clear
FLN #9	Flush Face Nozzle - Dark Green
FLN #10	Flush Face Nozzle - Gray NI
FLN #11	Flush Face Nozzle - Bronze
FLN #12	Flush Face Nozzle - Orange
FLN #16	Flush Face EVAC Nozzle - Black

Part No.	Description
FLR #1	Flush Face Receiver - Red
FLR #2	Flush Face Receiver - Gold
FLR #3	Flush Face Receiver - Teal
FLR #4	Flush Face Receiver - Violet
FLR #5	Flush Face Receiver - Dark Blue
FLR #6	Flush Face Receiver - Brown
FLR #7	Flush Face Receiver - Blue/Gray
FLR #8	Flush Face Receiver - Clear
FLR #9	Flush Face Receiver - Dark Green
FLR #10	Flush Face Receiver - Gray NI
FLR #11	Flush Face Receiver - Bronze
FLR #12	Flush Face Receiver - Orange



FLN #16 Universal Drain Nozzle Fits All FLR Receivers.

FloMAX Flush Face Grease Connectors

US PATENT #9708173

- Can be connected and disconnected under pressure. An industry first, demonstrating Flomax innovation.
- 5000 PSI rated.
- New patented design uses an internally sealed ball lock mechanism to ensure trouble free performance even in the most harsh of conditions.
- All Stainless Steel construction ensures long life and repeatable performance.
- Receiver has a built in check valve.
- 1" FNPT on both receiver and nozzle for maximum flow and adaptability.
- World Class performance and flow.
- Fail Safe shut off for safety.
- Flush face design helps ensure vehicle and part cleanliness.
- Two sizes available.



21 Fuel Vents

FloMAX fuel vents are made from all metal components. Our billet aircraft grade aluminum cap provides superior strength and impact resistance as compared to the inferior and weaker plastic and cast aluminum caps on other vents. The float and sealing balls are housed in a rigid aluminum ball tube. This ensures a positive seal and repeatable performance. The stem tubes are available in standard 5", 7", 9", 11" and custom customer specified lengths. Several configurations are available including threaded outlets, rotatable vent top, anti-vandalism and half couplings for welding into a tank.

- **Captured ball design ensures repeatable performance.**
- **Robust all billet aluminum construction.**
- **Available in different lengths and outlet/inlet configurations.**

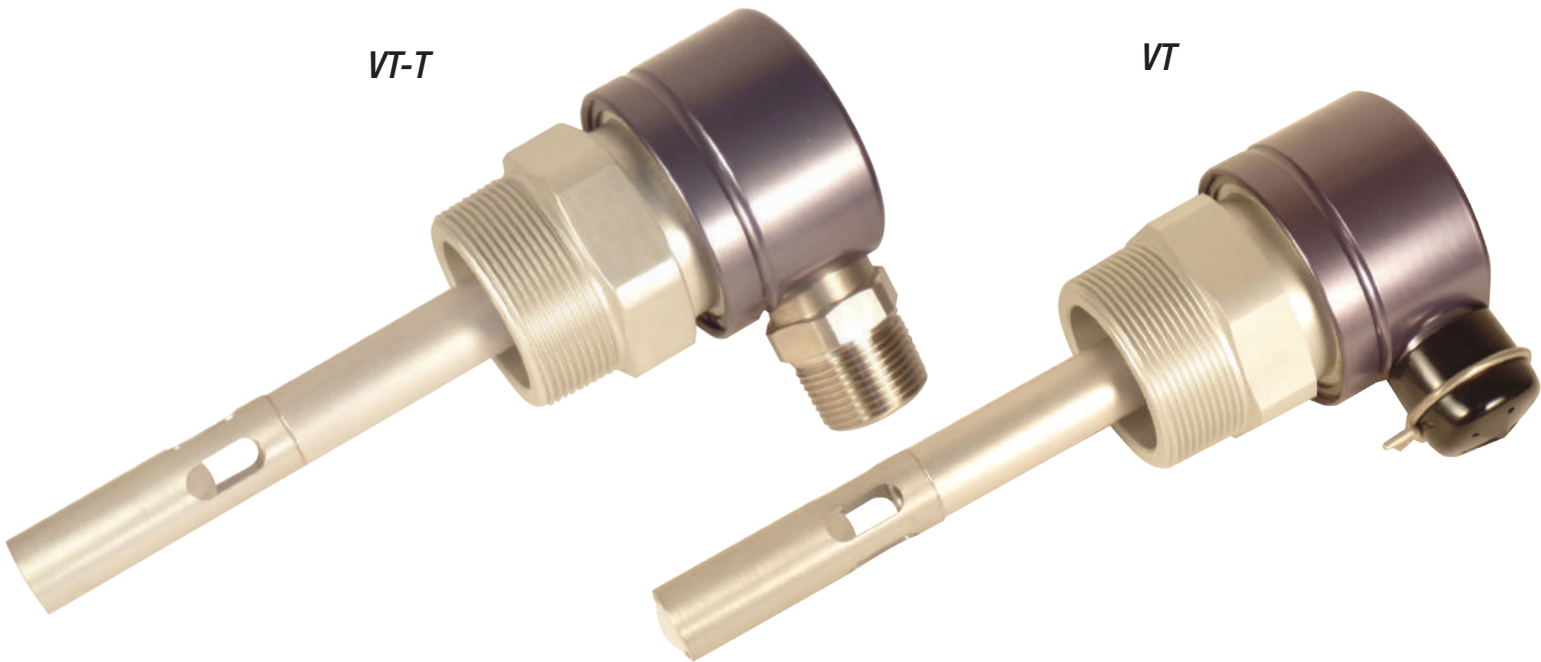

Standard Fuel Vents

Part No.	Description
VT	Fuel Vent - Standard (5" stem)
VT-7	Fuel Vent - Ext Stem (7" stem)
VT-9	Fuel Vent - Ext Stem (9" stem)
VT-11	Fuel Vent - Ext Stem (11" stem)
VT-C	Fuel Vent - w/Half Coupling (5" stem)
VT-C-7	Fuel Vent - w/Half Coupling (7" stem)
VT-C-9	Fuel Vent - w/Half Coupling (9" stem)
VT-C-11	Fuel Vent - w/Half Coupling (11" stem)
VT-A Sleeve	Fuel Vent - Anti Vandalism Sleeve
VT-A-7	Fuel Vent - Anti Vandalism (7" stem)
VT-A-9	Fuel Vent - Anti Vandalism (9" stem)
VT-A-11	Fuel Vent - Anti Vandalism (11" stem)
VT-T	Fuel Vent - Male Threaded Outlet (5" stem)
VT-T-7	Fuel Vent - Male Threaded Outlet (7" stem)
VT-T-9	Fuel Vent - Male Threaded Outlet (9" stem)
VT-T-11	Fuel Vent - Male Threaded Outlet (11" stem)

Part No.	Description
VT-TF	Fuel Vent - Female Threaded Outlet (5" stem)
VT-TF-7	Fuel Vent - Female Threaded Outlet (7" stem)
VT-TF-9	Fuel Vent - Female Threaded Outlet (9" stem)
VT-TF-11	Fuel Vent - Female Threaded Outlet (11" stem)
VTF	Fuel Vent with Filter - Standard (5" stem)
VTF-7	Fuel Vent with Filter - Standard (7" stem)
VTF-9	Fuel Vent with Filter - Standard (9" stem)
VTF-11	Fuel Vent with Filter - Standard (11" stem)
VTF-T	Fuel Vent with Filter - Male Threaded Outlet (5" stem)
VTF-T-7	Fuel Vent with Filter - Male Threaded Outlet (7" stem)
VTF-T-9	Fuel Vent with Filter - Male Threaded Outlet (9" stem)
VTF-T-11	Fuel Vent with Filter - Male Threaded Outlet (11" stem)
VTF-TF	Fuel Vent with Filter - Female Threaded Outlet (5" stem)
VTF-TF-7	Fuel Vent with Filter - Female Threaded Outlet (7" stem)
VTF-TF-9	Fuel Vent with Filter - Female Threaded Outlet (9" stem)
VTF-TF-11	Fuel Vent w/ Filter-Female Threaded Outlet (11" stem)

FloMAX fuel vents are made from all metal components. Our billet aircraft grade aluminum cap provides superior strength and impact resistance as compared to the inferior and weaker plastic and cast aluminum caps on other vents. The float and sealing balls are housed in a rigid aluminum ball tube. This ensures a positive seal and repeatable performance. The stem tubes are available in standard 5", 7", 9", 11" and custom customer specified lengths. Several configurations are available including threaded outlets, rotatable vent top, anti-vandalism and half couplings for welding into a tank.

- **Robust all billet aluminum construction.**
- **Available in different lengths and flow rates.**
- **Highest flowing vent in the industry.**
- **Capable of handling 400 GPM fluid flows.**
- **Fits standard 2" NPT openings.**

VTX-F-RT

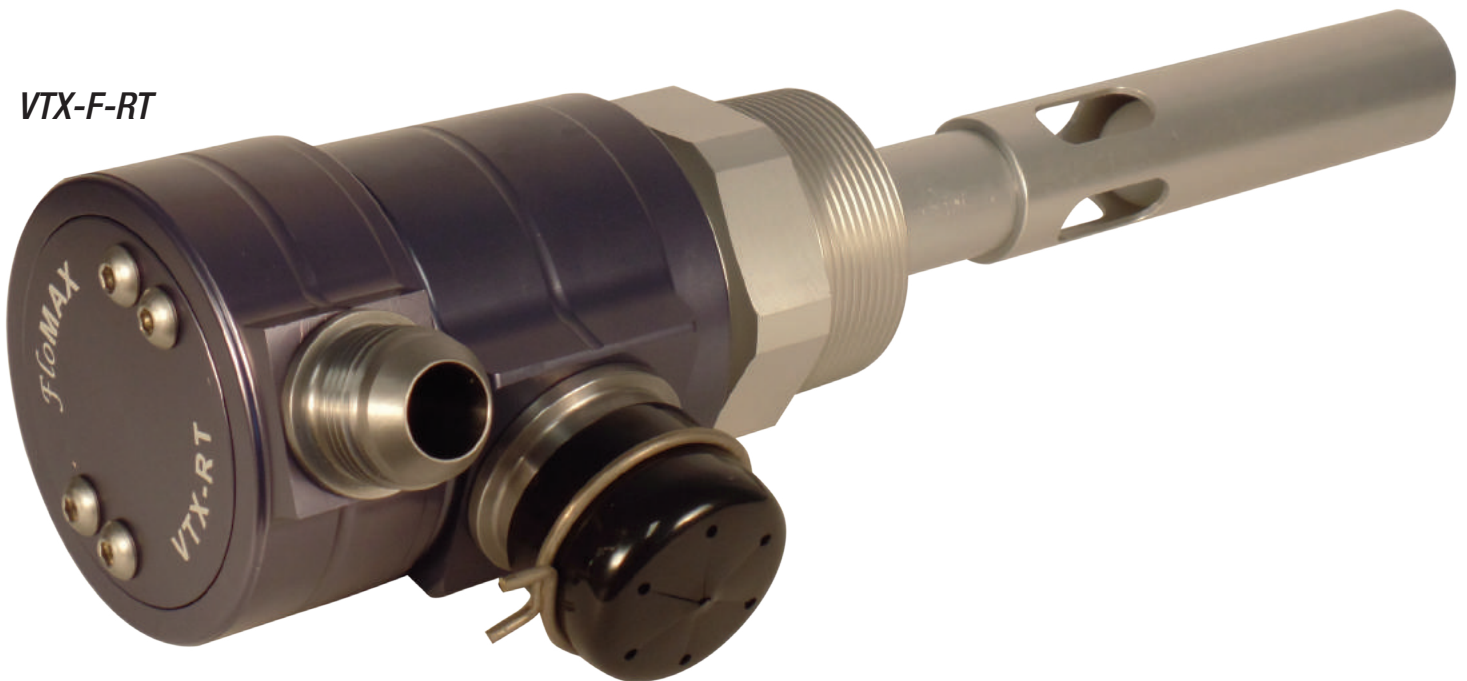

VTX vent is the highest flowing vent for pressure fill applications in the industry. It can flow over 400 GPM of fluid inflows. Enough to use with our industry leading FX1500 Fuel nozzle. Machined ball cage is robust in all harsh environments and will not break like spring ball cages do.

High Flow Vents

Part No.	Description
VTX	High Flow Vent - Standard (5" stem)
VTX-7	High Flow Vent - Ext Stem (7" stem)
VTX-9	High Flow Vent - Ext Stem (9" stem)
VTX-11	High Flow Vent - Ext Stem (11" stem)
VTX-C	High Flow Vent - w/Half Coupling (5" stem)
VTX-C-7	High Flow Vent - w/Half Coupling (7" stem)
VTX-C-9	High Flow Vent - w/Half Coupling (9" stem)
VTX-C-11	High Flow Vent - w/Half Coupling (11" stem)

Part No.	Description
VTX-A Sleeve	High Flow Vent - Anti Vandalism Sleeve
VTX-A-7	High Flow Vent - Anti Vandalism (7" stem)
VTX-A-9	High Flow Vent - Anti Vandalism (9" stem)
VTX-A-11	High Flow Vent - Anti Vandalism (11" stem)
VTX-F-RT-5	High Flow Vent-Filter capable rotatable top (5" stem)
VTX-F-RT-7	High Flow Vent Filter capable rotatable top (7" stem)
VTX-F-RT-9	High Flow Vent Filter capable rotatable top (9" stem)

23 Swivels and 1500 PSI Connector Series

FloMAX swivels feature an all stainless steel and aircraft grade aluminum construction and have a 37% greater flow than other industry swivels. The swivels are sealed with fluoro silicone O-rings to ensure the best performance in a variety of weather conditions. They come in a variety of size and configurations to match up with any standard nozzle and hose sizes.

- **Thirty two stainless steel ball bearings.**
- **Durable Stainless steel and Aluminum construction.**
- **Many sizes and configurations are available.**



Part No.	Description
FNBS	FloMAX 1 1/2" Nozzle Swivel
FNBS2	FNBL nozzle thread to 2" NPT female
FNS-SP	1 1/2" NPT x 2" NPT female
FX1500 Swivel	FloMAX 2" High Flow Nozzle Swivel

Part No.	Description
FNS	Standard Fuel Swivel 1 1/2" NPT by 1 1/2" NPT
FNS2	Standard Fuel Swivel 2" NPT by 1 1/2" NPT
SW2	Swivel 2" NPT by 2" NPT
FNSID	Inline Double Nut Swivel 1 1/2" NPT by 1 1/2" NPT
FX25	FX1500 Turocad to 2.5" FNPT

The FloMAX 2 inch and 3 inch break away valves are constructed of zinc plated steel and anodized aircraft grade aluminum. The valves are designed with three shear studs that will break at a designated force when mounted correctly using our factory approved mount. This will help protect expensive refueling equipment and help prevent catastrophic fuel spillage.

- Eliminates expensive equipment damage.
- Eliminates catastrophic spills.
- 250 PSI pressure rating.

BAV's must be used with mounting brackets

See BAV2M below

BAV3 3" NPT Valve

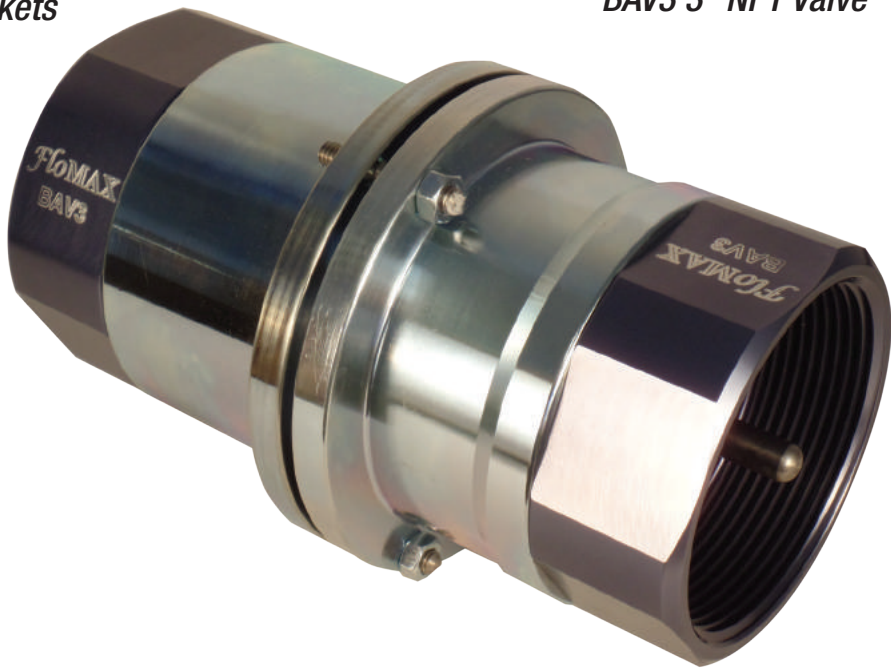

BAV2 2" NPT Valve



BAV2M



Part No.	Description
BAV	Break Away Valve 2 Inch
BAV2M	Break Away Valve Mount 2 Inch
BAV3	Break Away Valve 3 Inch
BAV3M	Break Away Valve Mount 3 Inch
BAV-K1	Break Away Valve Replacement Kit

25 3" Inch Fuel Nozzle and Receivers

FloMAX 3" fuel nozzles and receivers are designed for high flow volume and ease of use. They are scaled down versions of the standard API 5" specification parts. Poppets have a vulcanized viton seal surface. Both the nozzle and receiver are made from aircraft aluminum and stainless steel. The connectors have a flow rating of up to 1200 GPM at 100 PSI.

- **Ultra High Flow for demanding fueling requirements.**
- **Robust Billet Aluminum Construction.**
- **1200 GPM at 100 PSI.**

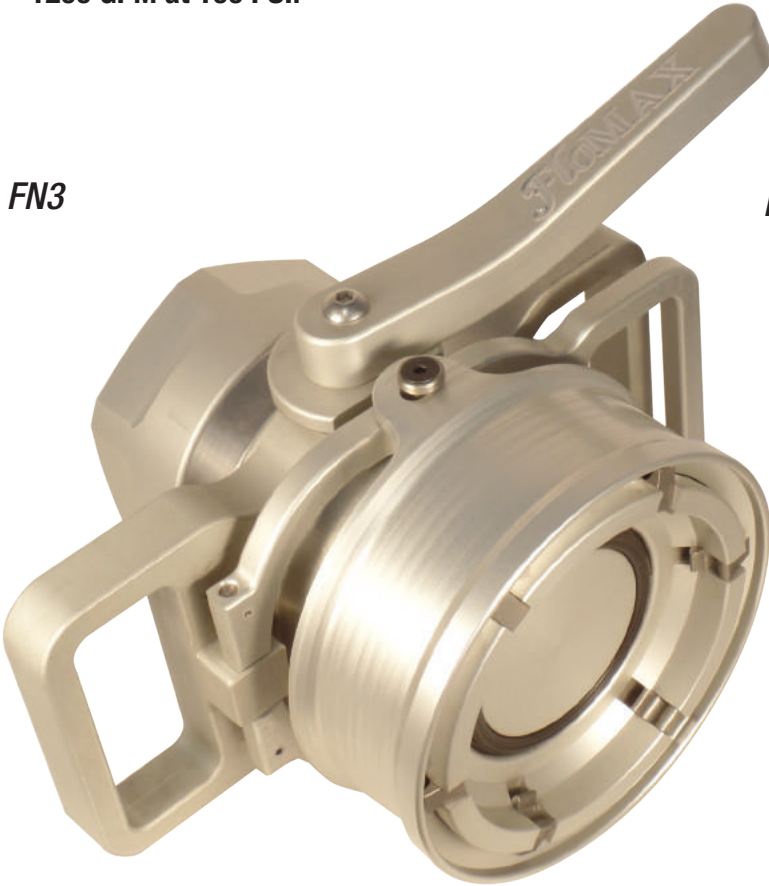

FN3

FR3



Part No.	Description
FN3	Fuel Nozzle 3 Inch
FR3	Fuel Receiver 3 Inch with 3 " NPT Base
FR3-F	Fuel Receiver 3 Inch with Flange Base
FR3-4NPT	Fuel Receiver 3 Inch with 4 " NPT Base

Part No.	Description
FR3-NP	Fuel Recvr 3 Inch w/ Non-Pressure Valve - 4" NPT threads
FR3-NP-4NPT	3 Inch Non-Pressure Valve with 4" NPT Front End
FR3-NP-3NPT	3 Inch Non-Pressure Valve with 3" NPT Front End

FR3-F



FR3-NP



FloMAX Gravity fill receivers are made from aircraft grade aluminum. They have a welded on cast aluminum handle for strength and convenience. They come in a standard 1 1/2" diameter as well as a smaller 1" diameter size for filling smaller fuel tanks. They are available in straight, 45 degree bend and a 90 degree bend configuration.

- 1 1/2" and 1" sizes available.
- Straight, 45 degrees and 90 degree bend.
- Fits standard 1 1/2" fuel receivers.
- Allows transfer of fluid without using a standard fuel receiver.

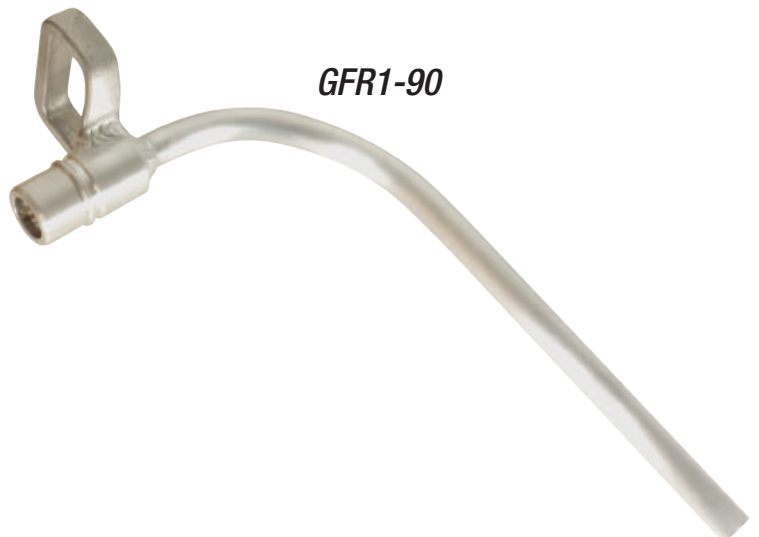
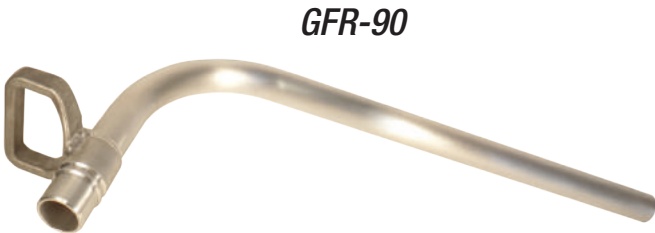
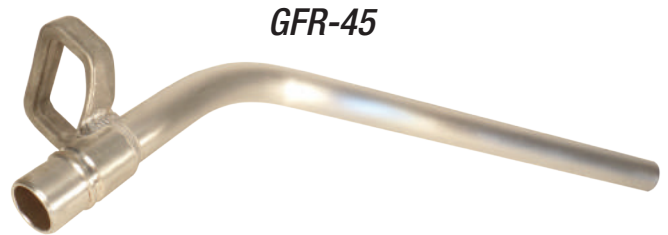
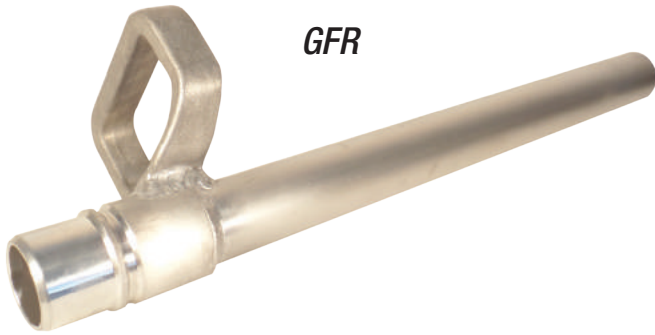

Part No.	Description
GFR-0	Gravity Fill Fuel Receiver, Straight
GFR-45	Gravity Fill Fuel Receiver, 45 deg.
GFR-90	Gravity Fill Fuel Receiver, 90 deg.
GFR1-0	Gravity Fill Fuel Receiver 1", Straight
GFR1-45	Gravity Fill Fuel Receiver 1", 45 deg.
GFR1-90	Gravity Fill Fuel Receiver 1", 90 deg.

FNBL-100



FNBL-102



FNBL-104



FR EX SOCKET



FNM



FR SOCKET



FN600-101



FX1500 Tools

FX1500-100



FX1500-102



FX1500-104



Part No.	Description
FNBL-100	Poppet Spanner wrench
FNBL-102	Poppet insertion tool
FNBL-104	Swivel Spanner Wrench
FR-EX Socket	Fuel Receiver Socket Extended Length
FR-Socket	Fuel Receiver Socket
FN600-101	FN600 Nose Spanner Wrench
FNM	Fuel Nozzle Mount
FX1500-100	FX1500 Fuel Nozzle Poppet Spanner Wrench
FX1500-102	FX1500 Fuel Nozzle Poppet Insertion Tool
FX1500-104	FX1500 Fuel Nozzle Swivel Spanner Wrench
BH-W	Bell Housing Weld On Attachment
BH-F	Bell Housing Bolt On Attachment

Bell Housings

BH-W
Weld On



BH-F
Bolt On



Stainless Steel External Non Pressure System. All external components are made of 300 series Stainless Steel for long life in more harsh and corrosive environments.

HFRE Evacuation Receiver. A special EVAC fitting to fit in the oil pans of Komatsu equipment and others. The HFRE has a special one way check valve that only allows the fluid to be withdrawn or drained from the fitting. It helps fix the problem with some oil pans having easily stripped out threads during repeated oil drain cycles.

HFRE-C #9



NPS-1-SS



NP-SU



HFRE



R-HR-C 1" NPT

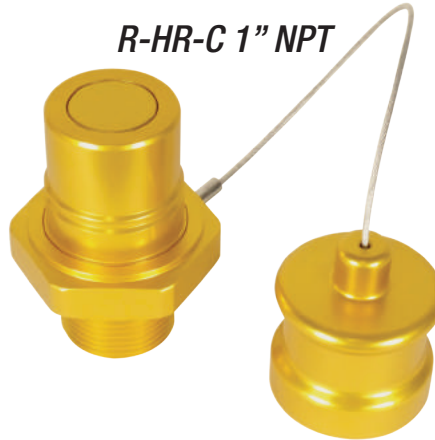

ENBL-12P



ERS-12C



Part No.	Description
HFRE-C #9	Fits Komatsu Oil Pans For a Quick Drain
NP-SU	Non Pressure System Low Profile Sending Unit
ERS-12C	Engine Receiver Green ½" NPT
ENBL-P#12	Engine Nozzle Green ½" NPT
R-HR-C1 NPT	R-HR-C with 1" NPT
R-HR-C	With 1" NPTM
NPS-1-SS	All External Components are 300 Stainless Steel

29 Adapters

Flomax has a large variety of adapters to fit many tank configurations.

MFF10335

Small Diameter 2" NPT to 6 Bolt.



MFF10577

Large Diameter 2" NPT to 6 Bolt.



MVA32-MF2

2" NPT Male to 2" Adaptor 2" Long.



MVA32-MF3

2" NPT Male to Female 3" Long.



MVA32-MF4.5

2" NPT Male to Female 4.5" Long.



MVA32-MF2.5

Face Seal to 2" NPT. 2" Long.



MVA32FL 8 bolt

2" NPT 8 Bolt Adapter.

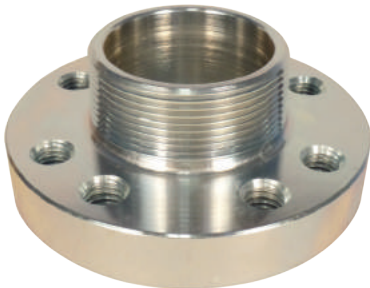

FR-VR

VR300 to 2" NPT



MVA-32-OFS

Face Seal to 2" NPT. 4.5" Long.



FR P Cap and FRX P Cap are a Flomax innovation for an easily installed and removed fuel receiver cap. The push to connect design allows easy installation in all weather conditions. The FR P cap fits all standard fuel receivers. The FRX P Cap fits our high flowing 2" FRX Fuel receivers.

FR-P Cap and FRX-P Cap Available. Spring Clip Option Available For All Fuel Receivers.

FRX-BFN-P



BFN

FRX-P-Cap



FR-P Cap



FRX Fuel Receiver

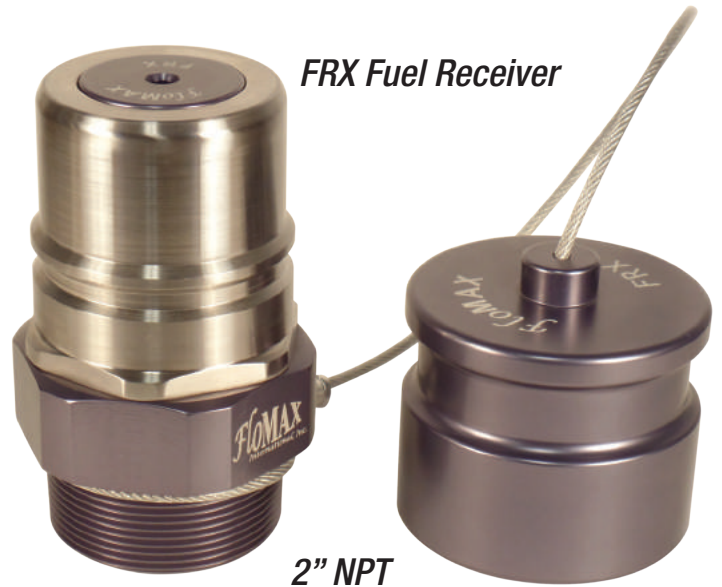

2" NPT

Bulk Transfer Nozzle

- Push to connect design
- Fits standard 1 1/2" and 2" FRX fuel receivers
- Allows transfer of fluid without using a fuel nozzle

Part No.	Description
BFN	Bulk Fuel Nozzle
BFN-P	Bulk Fuel Nozzle with Plug
BFN Plug	Bulk Fuel Nozzle Plug
FRX-P Cap	Push to Connect Cap for FRX Receivers
FR-P Cap	Push to Connect Cap for 1 1/2" Receivers
FRX BFN	Bulk Fuel Nozzle for FRX fuel receivers
FRX-BFN-P	Bulk Fuel Nozzle for FRX fuel receivers with Cap

Not a page

FLOMAX INTERNATIONAL



Phone: 801-489-3329 • Fax: 801-489-3326
1295 West 1650 North • Springville, UT 84663 • USA
www.flowmaxinternational.com

Rev1:10:2018